



Photo By: Rik Soderlund

Friday 12th June 2020 – Thursday 25th June 2020

\$2.00 per issue



The Cocos (Keeling) Islands comprises of 27 coral islands forming two atolls—situated 2768km north-west of Perth and 3685km due west of Darwin — and is an isolated speck in the Indian Ocean.



You can subscribe to The Atoll electronically by contacting:
cocosislands@crc.net.au

In this edition
Isi Kandungan

Cocos (K) Islands News <i>Berita Pulu Cocos (K)</i>	3
Public Notices <i>Notis-notis Umum</i>	12
Games <i>Kemainan</i>	15
Cocos Moment <i>Saat Cocos</i>	17
Community Events <i>Acara Masyarakat</i>	18



Trainee skippers and crews - CKI Future endeavours.



Rainfall Stats

Monthly Statistic up to 11th

June:
3.8mm

Latest 2020 Statistics:



759.6mm

LATEST WEATHER

www.bom.gov.au

Emergency Contact List

AFP 9162 6600
VHF Ch20

IOTHS WI Clinic 9162 6655
IOTHS HI Clinic 9162 7609
VHF Ch24

DFES HI 9162 7788
DFES WI 9162 7777

VMRS VHF Ch20

Shire HI 9162 6649
Shire WI 9162 6740

Watercorp 9162 6722

Thumbs Up

- 👍 To having the Wednesday evening ferry back.
- 👍 To everyone who organized the welcome to the new residents on Sunday night.
- 👍 Jukong Club for being proactive maintaining the tradition of the Cocos Malay water sport and to the VMRS and support boats for keeping everyone safe.
- 👍 Pak Zuhaili for a fantastic job organizing his karaoke machine for the community to enjoy.

Feel free to email your thumbs up to the Shire for inclusion.

FROM THE CEO'S DESK - 12 JUNE 2020



ASSISTING BUSINESS WITH COVID-19 COMPLIANCE: The Shire has been assisting the Territory Controller and IOTA in promoting Covid-19 Safety Plans for businesses. To further assist our businesses with their compliance and management, the Shire has produced Covid-19 Safety Compliance Kits for businesses. Please contact Ibrahim Macrae, our Governance Coordinator on 9162 6649 governance@cocos.wa.gov.au if you haven't received a kit and would like one.

MEMBANTU BISNIS DENGAN PENEMUHAN COVID-19: *Konsel telah membantu Territory Controller dan IOTA dalam mempromosikan Plan Keselamatan Covid-19 untuk bisnis-bisnis. Untuk lebih membantu bisnis-bisnis kami dengan penemuan dan pengurusannya, Shire telah menghasilkan Kit Keselamatan Covid-19 untuk bisnis-bisnis. Sila hubungi Pak Yusri, Governance Coordinator kami dinomor 9162 6649 governance@cocos.wa.gov.au jika anda belum menerima kit dan menginginkannya.*

DISABILITY ACCESS AND INCLUSION PLAN (DAIP): After gathering valuable community input, the Shire's first DAIP has been drafted. In addition to being a legislative requirement, the DAIP provides guidance on how we can make sure our services and facilities are inclusive for all members of our community. The draft DAIP is on the Shire website [https://shire.cc/images/2020/Disability Access and Inclusion Plan draft.pdf](https://shire.cc/images/2020/Disability%20Access%20and%20Inclusion%20Plan%20draft.pdf) for public comment before being presented formally to Council. Please contact Isa Minkom, Community Development Coordinator on 9162 6649 cdc@cocos.wa.gov.au if you would like a copy of the draft DAIP or to offer any comments on the draft. I would like to offer a sincere note of thanks to Tess Dyson for her work on the DAIP.

PLAN AKSES DAN INCLUSION UNTUK ORANG YANG KETIDAK KEMAMPUAN (DAIP): *Setelah mengumpulkan input masyarakat yang berharga, DAIP pertama Shire telah disusun. Selain menjadi persyaratan perundangan, DAIP memberikan panduan tentang bagaimana kami dapat memastikan serbis dan kemudahan kami inklusif untuk semua masyarakat. Draf DAIP terdapat di laman [https://shire.cc/images/2020/Disability Access and Inclusion Plan draft.pdf](https://shire.cc/images/2020/Disability%20Access%20and%20Inclusion%20Plan%20draft.pdf) untuk komen orang ramai sebelum disampaikan secara rasmi kepada Konsel. Sila hubungi Pak Indra, Community Development Coordinator dinomor 9162 6649 cdc@cocos.wa.gov.au jika anda mahukan salinan draf DAIP atau untuk memberikan komen mengenai draf tersebut. Saya ingin mengucapkan*

ribuan terima kasih kepada Tess Dyson atas kerjanya di DAIP.

ORAL HISTORY PROGRAM: The Shire has been working in partnership with the Visitor Centre to record oral histories from members of the community on Home Island over the past twelve months. Oral histories are an invaluable resource for current and future generations and provide a primary source of historical knowledge.

On Home Island we have been working in collaboration with Cocos Keeling Islands Visitor Centre and Parks Australia to support four Emerging Curators, Lanif Yakin, Siddiq Juljali, Shaniyah Kenneth and Amallia Alim in recording oral histories. To-date the four curators have interviewed eight Cocos Malay elders. The topics covered range from the art of jukung building to everyday life as experienced in the "olden days" as the elders refer to it, and the more significant events such as the Act of Self Determination.

We are grateful to the team at the Visitor Centre who are currently compiling all the interviews, having them translated into English and collecting old photos as reference to events discussed in the interviews.

We are now delighted to expand the program to commence gathering oral histories of people on West Island. It will be wonderful to have the stories of people who have contributed to the development of Cocos, to make it what it is today, captured for current and future generations to enjoy and learn from. These stories will be made available to the community via a variety of mediums, including at a community event in the coming weeks. If you have a Cocos story and would like to have your story recorded, please contact Isa Minkom at the Shire and we will arrange for you to be interviewed.

Isa is also keen to hear from people who would like to get involved as an interviewer or in assisting with transcribing the oral histories. Training and equipment will be provided.



FROM THE CEO'S DESK - 12 JUNE 2020



PROGRAM SEJARAH ORAL: Shire telah bekerjasama dengan Visitor Centre untuk merakam sejarah dari anggota masyarakat di Home Island sejak dua belas bulan terakhir. Sejarah oral adalah

sumber yang tidak ternilai untuk generasi semasa dan yang akan datang dan menyediakan sumber utama pengetahuan sejarah.

Di Home Island, kami telah bekerja sama dengan Cocos Keeling Islands Visitor Centre dan Parks Australia untuk mendukung empat Kurator yang muncul, Lanif Yakin, Siddiq Juljali, Shaniyah Kenneth, dan Mak Asif dalam merekod sejarah oral.

Sampai saat ini keempat kurator telah interview delapan nenek-nenek Melayu Cocos. Topik yang dibuat bermula dari membuat jukong hingga kehidupan sehari-hari seperti yang dialami pada "masa lalu" sebagaimana nenek-nenek menyebutnya, dan peristiwa yang lebih signifikan seperti Hari Tiga Pilihan.

Kami sekarang senang untuk memperluaskan program untuk memulai mengumpulkan sejarah oral orang-orang di Pulu Panjang. Akan luar biasa memiliki kisah-kisah tentang orang-orang yang telah berkontribusi pada



pengembangan Cocos, menjadikannya seperti sekarang ini, ditangkap oleh generasi sekarang dan masa depan untuk dinikmati dan dipelajari. Kisah-kisah ini akan tersedia untuk masyarakat melalui berbagai media, termasuk di acara masyarakat dalam beberapa minggu mendatang. Jika anda memiliki kisah Cocos dan ingin agar cerita anda direkod, silakan hubungi Isa Minkom di Shire dan kami akan mengatur agar anda diinterview.

Isa juga ingin mendengar dari orang-orang yang ingin terlibat sebagai pewawancara atau dalam membantu menuliskan sejarah oral. Pelatihan dan peralatan akan disediakan.

ARTS GROUP: Thank you to the small but passionate group of people who have registered to be on an informal group keen to assist the Shire in developing and implementing an arts and cultural program on Cocos. At the first meeting of the group we came up with several ideas we would like to progress together. Some of the ideas so far include an annual exhibition, art trail, workshops and artists in residence program, poetry in the pub, music and dance. If you would like to be involved and join this lively group of people interested in the arts, please contact Isa Minkom.

KUMPULAN SENI: Terima kasih kepada sekumpulan kecil tetapi bersemangat yang telah mendaftar untuk menyertai kumpulan tidak rasmi yang berminat untuk membantu Shire dalam mengembangkan dan melaksanakan program seni dan budaya di Cocos. Pada perjumpaan pertama kumpulan kami mengemukakan beberapa idea yang ingin kami majukan bersama. Separoh idea setakat ini termasuk exhibiton tahunan, jejak seni, workshop dan seniman dalam program kediaman, puisi di pub, muzik dan tarian. Sekiranya anda ingin terlibat dan menyertai kumpulan orang yang berminat dengan seni ini, sila hubungi Pak Indra.

MAJU PULU KITA MASTERPLAN PROJECTS: The Home Island Cyclone Shelter is a bit of a construction site this week as the shelter over the steps is being installed. Once installed this will provide a great venue for an outdoor cinema/theatre space and in the coming weeks, we will commence a program for the community to enjoy.

Recycling on Home Island was another priority project in the Maju Pulu Kita Masterplan so we were excited to receive the glass crusher and can crusher on the last ship. This equipment will be installed in the coming weeks. We will be delivering information on recycling to each household plus running a series of open days for community groups to have a look at the equipment in action.

PROJEK MASTERPLAN MAJU PULU KITA: Rumah Seklon di Home Island minggu ini seperti tempat pembinaan kerana tempat perlindungan di atas tangga sedang dipasang. Setelah dipasang ini akan menjadi tempat yang bagus untuk menonton wayang diluar dan dalam beberapa minggu akan datang, kami akan memulakan program untuk dinikmati oleh masyarakat.

Recycling di Home Island adalah satu lagi projek keutamaan dalam Maju Pulu Kita Masterplan, jadi kami sangat gembira menerima penghancur kaca dan belek di kapal yang lalu. Peralatan ini akan dipasang pada minggu-minggu mendatang. Kami akan menyampaikan maklumat mengenai recycling ke setiap rumah dan menjalankan beberapa hari terbuka bagi kumpulan masyarakat untuk melihat peralatan yang sedang beraksi.



Quote of the Day

*You must tell yourself,
"No matter how hard it is,
or how hard it gets, I'm
going to make it."*

Les Brown

Thought for the Day

*When problems come into
your life like non-stop
rain, remember that your
positive attitude will
always be your umbrella*

Jokes of the Week



Parallel lines have so much in common. It's a shame they'll never meet.

Two factory workers are talking. The woman says, "I can make the boss give me the day off." The man replies, "And how would you do that?" The woman says, "Just wait and see." She then hangs upside down from the ceiling. The boss comes in and says, "What are you doing?" The woman replies, "I'm a light bulb." The boss then says, "You've been working so much that you've gone crazy. I think you need to take the day off." The man starts to follow her and the boss says, "Where are you going?" The man says, "I'm going home, too. I can't work in the dark."

Pappu: My internet is not working properly...
Officer: Ok, Double click on "My computer"
Pappu: I can't see your computer..
Officer: No no.. click on "My computer" on your computer..
Pappu: How can I click on your computer from my computer?
Officer: Listen.. There is an icon labelled "My Computer" on your computer. Ok. double click on it.
Pappu: What the hell, what is your computer doing on my computer???
Officer: Double click on your computer.
Pappu: On which icon I've to click.
Officer: "My Computer".
Pappu:...Oh u Idiot..... Tell me where is your office...I'll come there and click on your "Computer".

FROM THE CEO'S DESK - 12 JUNE 2020

MUSEUM/RICE STORE HERITAGE BUILDING: The old Rice Store, currently the Museum/Visitor Centre on Home Island has recently had some urgent remedial works by way of re-pointing of bricks. This work was essential to preserve the structure of this invaluable heritage building. Once this has had a chance to dry, the building will be re-painted and will be looking as good as new. Well done to the crew on a great job.

BANGUNAN WARISAN MUSEUM/RUMAH BERAS: Rumah Beras yang lama, yang kini menjadi Museum/Visitor Centre di Home Island, baru-baru ini dibuat beberapa pekerjaan untuk menunjuk semula batu bata. Kerja ini sangat mustahak untuk memelihara struktur bangunan warisan yang tidak ternilai ini. Apabila sudah kering, bangunan akan dicat semula dan akan kelihatan bagus seperti baru. Kerja yang bagus kepada pekerja untuk pekerjaan yang hebat.



These are just a quick summary of some of the current Shire activities that may be of interest to our community. As always, community members are more than welcome to contact me at any stage to discuss the details of any other items of interest or concern.

Ini hanyalah berita ringkas berkenaan beberapa aktiviti Shire yang terkini yang mungkin menarik minat masyarakat kami. Seperti biasa, masyarakat boleh menghubungi saya bila-bila untuk membincangkan perkara-perkara lain yang menarik atau menjadi perhatian.



LOCAL GOVERNMENT ACT 1995 (WA) (CKI)
Shire of Cocos (Keeling) Islands
Proposed Local Law

The Shire of Cocos (Keeling) Islands proposes to adopt the following local law –

1. Shire of Cocos (Keeling) Islands Public Places and Local Government Property Local Law 2020.
- 2.

Purpose – to prescribe for the management of public places and thoroughfares, and all local government property.

Effect – to repeal the *Camping Local Law 2009* and establish necessary local government property controls for activities in public places including thoroughfares, and for the use of/provide for permitted and prohibited activities on local government property and create offences for non-compliance.

A copy of the proposed local laws may be inspected at or obtained from –

- The Shire Office on Home Island during standard business hours or on West Island Tuesday and Thursday 12noon to 3pm.
- from the Shire of Cocos (Keeling) Islands website www.shire.cc
- by contacting the Shire Office on 9162 6649 or info@cocos.wa.gov.au

Submissions about the proposed local laws may be made by 12noon on Monday 3 August 2020.

- in writing to the CEO, or
- by email to info@cocos.wa.gov.au

Andrea Selvey
 Chief Executive Officer
 Shire of Cocos (Keeling) Islands

UNDANG-UNDANG KERAJAAN TEMPATAN 1995 (WA) (CKI)
Konsel Pulu Cocos (Keeling)
Cadangan Undang-undang Tempatan

Konsel Pulu Cocos (Keeling) mencadangkan untuk mengangkat undang-undang tempatan berikut –

1. *Tempat-tempat Publik Konsel Pulu Cocos (Keeling) dan Undang-undang Tempatan Harta Kerajaan 2020.*
- 2.

Tujuan - untuk menetapkan pengurusan tempat publik dan jalan raya, dan semua harta kerajaan tempatan.

Kesan - untuk mencabut Undang-undang Tempatan Kemping 2009 dan menetapkan kawalan harta benda pemerintah tempatan yang diperlukan untuk aktiviti di tempat publik termasuk jalan raya, dan untuk penggunaan / menyediakan aktiviti yang dibenarkan dan dilarang pada harta benda pemerintah tempatan, dan membuat pelanggaran untuk ketidakpatuhan.

Salinan undang-undang tempatan yang diusulkan dapat diperiksa di atau diperoleh dari –

- *Ofis Konsel di Home Island pada waktu bisnis biasa atau di Pulu Panjang hari Selasa dan Khamis jam 12 tenga hari hingga jam 3 petang.*
- *dari laman web Konsel Pulu Cocos (Keeling) www.shire.cc*
- *dengan menghubungi Ofis Konsel di 9162 6649 atau info@cocos.wa.gov.au*

Penyampaian mengenai undang-undang tempatan yang dicadangkan dapat dilakukan selewat-lewatnya pada jam 12 tenga hari Isnin 3 Ogos 2020.

- *secara bertulis kepada CEO, atau*
- *melalui e-mel ke info@cocos.wa.gov.au*

Andrea Selvey
 Chief Executive Officer
 Shire of Cocos (Keeling) Islands

The HI Gym was once a supermarket.

Shamroks supermarket was once the hardware store.

Cocos Malay Words

- * Teropan - Group
- * Rusak - Damage/broken
- * Bekakas - Tools/ equipment
- * Belayar - Sailing
- * Tebalek - Capsized
- * Belumba - Race
- * Tali - Rope
- * Selamatkan - Rescue



Do you want to report a wasp nest, a fallen coconut tree, a pothole, dumped rubbish or a broken playground equipment? Simply Snap, Send and Solve.

What is Snap Send Solve?

Snap Send Solve is a free app that allows the community to report issues promptly to the Shire.

How does it work?

Simply take a photo of the issue on the app and send the photo when you are in range. The Shire will receive a report with the GPS location and we will attend to the issue.

How do I get Send Snap Solve?

The free app is available to download from the iTunes App Store or the Google Play App Store. The app will make it easier and more efficient for the Shire to respond to issues in our Community.

You can also find a short video about Send, Snap and Solve on our Shire Facebook page.
Let's start – Snap, Send and Solve!



Apakah anda ingin melaporkan sarang wasp, pokok kelapa jatuh, lobang di jalanan, sampah dibuang keliling atau playground yang patah? Hanya perlu Snap, Send and Solve.

Apa ini Snap, Send Solve?

Petik, Hantar dan Selesaikan adalah app yang free di mana masyarakat boleh melaporkan masalah dengan lancar kepada Shire.

Bagaimana Caranya?

Sila petik gambar di app dan kirim gambar itu jika anda dalam kawasan internet. Shire akan terima report dengan lokasi GPS dan kami akan menguruskan masalah itu.

Bagaimana Saya Boleh Mendapatkan App Snap, Send Solve?

App ini adalah free dan boleh di download dengan senang dari iTunes App atau Google Play App Store.

App ini akan membuat ia lebih mudah dan lebih lancar untuk Shire bertindak balas kepada masalah di masyarakat kami.

Anda juga boleh mendapatkan video tentang Petik, Hantar dan Selesaikan pendek di Facebook Shire.

Sila mulai—Petik, Hantar dan Selesaikan!

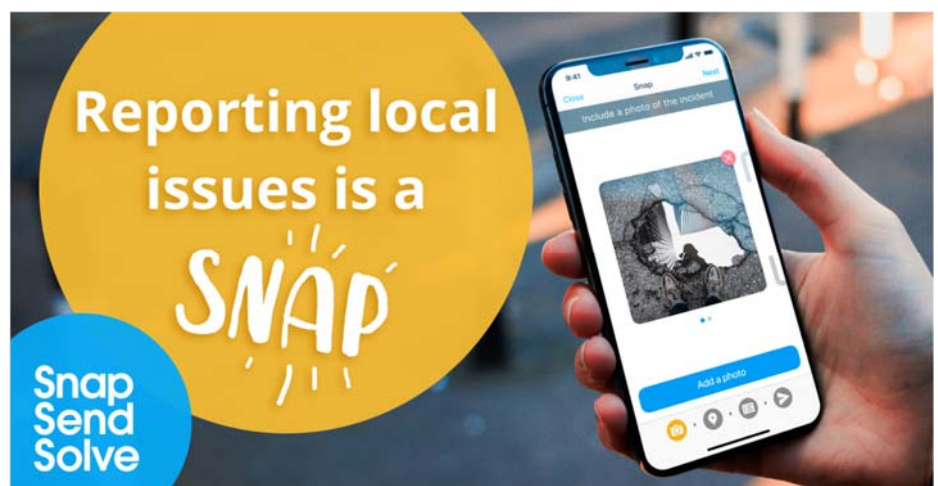



Home Island Gas Installation Inspections

Steve Holdham Senior Gas Inspector of Building and Energy conducted inspection activities on 30 October 2019. These inspections are carried out to ensure that the gas installations are compliant with the Gas Standards Act 1972 and its Regulations.

Inspectors Orders had been issued from a previous visit in 2018 for non-compliances that have been commonly identified on Home Island. There is a concern that these defects are not being rectified and there are numerous gas installations in use that are non-compliant.

2019 inspections identified that the most common non-compliances are as per below examples. These would be required to be rectified for compliance under current Regulations and Standards:



LPG cylinders unrestrained and/or not installed on an appropriate base or base material.

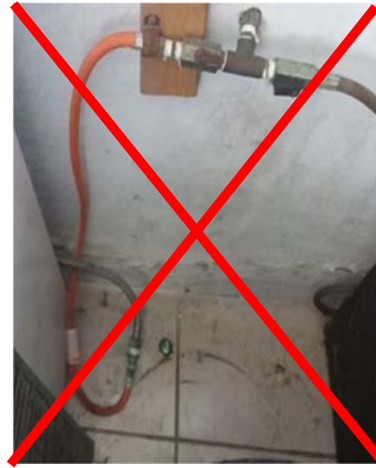

Flexible gas hose assemblies installed contrary to regulations.



Other common non-compliances identified include:

- LP Gas cylinders located too close to openings into buildings.
- LP Gas cylinders are prohibited from use indoors, appliances certified for outdoor use must only be used outdoors (camping style hot water units, cookers etc.)
- LP Gas cylinders too close to source of ignition.
- LP Gas cylinders gas/butane cartridge cookers located inside buildings.
- Appliance burners located too close to combustible materials.
- Inappropriate gas regulators (no overpressure protection).

Please see below diagram of the Regulations and Standards for gas installation requirements:

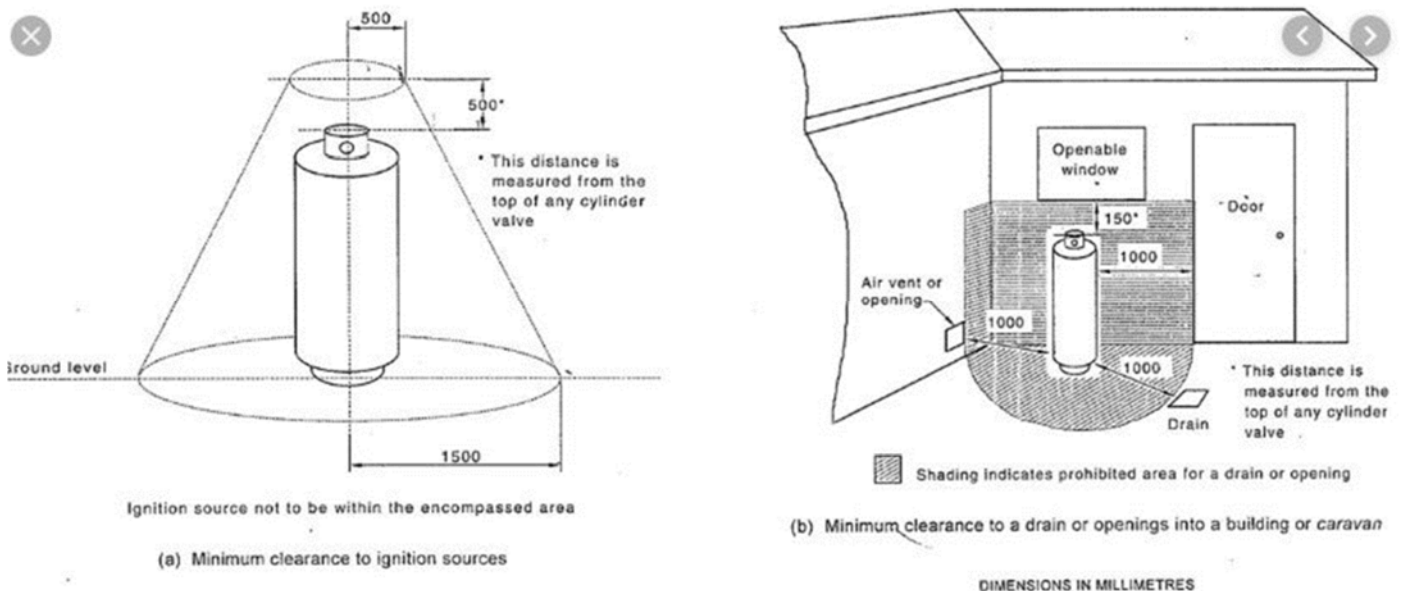

The Shire is working together with the senior gas inspector to ensure residents and business comply with current regulations and standards, in order to prevent unnecessary infringements and prosecutions.

Importantly it is about educating people to abide by the regulations to ensure potential risks and hazards are eliminated. Please be reminded that all gas installations can ONLY be done by a licensed gas fitter. An on the spot fine of \$2000 can be issued by the gas inspector for unauthorised gas fitting work.

More inspections shall take place in the near future, and any installations that were non-compliant before will be revisited and new orders will be issued for those properties relevant to any defects identified.

For more information regarding any gas fitting questions and issue please feel free to contact Steve Holdham (details below) or Luluk Sloan at the Shire.

Steve Holdham | Senior Gas Inspector
 Building and Energy Division
 Department of Mines, Industry Regulation and Safety
 303 Sevenoaks Street Cannington WA 6107
 Tel: +61 8 6251 1918
steve.holdham@dmirs.wa.gov.au | www.dmirs.wa.gov.au

Community Update Pulu Keeling National Park



Notification of intention to bait yellow crazy ants

Parks Australia would like to notify the Cocos community of our intention to bait for yellow crazy ants on Pulu Blan Madar in the coming weeks. We have recently noticed exceptionally high numbers of crazy ants which have the potential to impact on the survivorship of the Christmas Island blue tail skinks. The baiting will only take 1-2 days but will be repeated 3 times, every 3 months. We will be using Fipronil based gel inside small containers which will only allow access to ants.

Despite efforts to keep Pulu Blan Madar rat free, we have had a recent rat incursion. We have installed 4 Good Nature traps both on Blan and Blan Madar to attempt to keep rat numbers at a minimum.

If visiting Pulu Blan or Blan Madar, please remember to check your boat for unwanted pests like rats, centipedes and paper wasps. It is critical for the survival of the skinks that the islands remain pest free.

PKNP Community Management Committee update



Left: Our 2019 Committee

Missing from this image is Nek Umar, Nek Nazif and David McKinney.

We thank outgoing members Bob Watson, Peter Wicks, Andrea Selvey and Haji Badlu as they step down from our Community Management Committee. Terima kasih Haji Badlu for your commitment to our meetings and your valuable historical insight for over 15 years.

We welcome Cr Jamil Ibram to the Committee for 2020.

Photo credit: Rik Soderlund

We currently have two vacancies on our voluntary Committee, which was established in 1995 when the Park was first proclaimed. If you have an interest in the management of Pulu Keeling, then please express your interest on 9162 6678 or pulukeelingnationalpark@awe.gov.au by Friday 19th June. Our committee members are very valued.

We recently installed an interpretive sign at the site known as Nek Katek's grave in PKNP. This is one of our projects that our Committee helped us with. We would also like to acknowledge Nek Amansha, Nek Su, Wak James, JCR, the Shire and ABF who all helped us to find this story and make the site a place of remembrance and reflection.

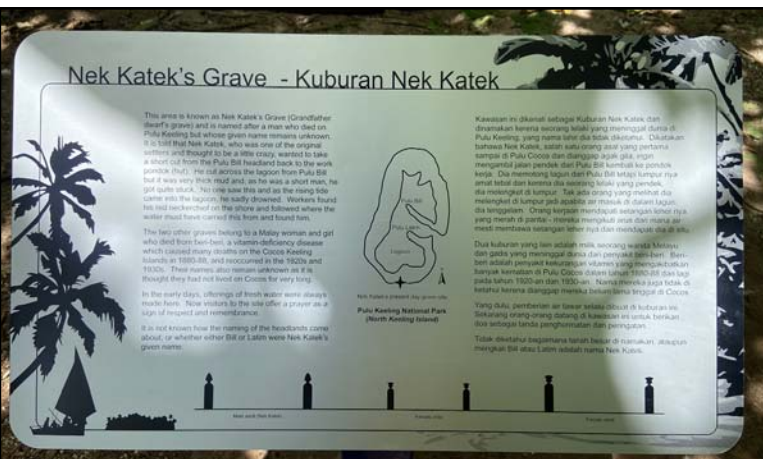



Berita Masyarakat Pulu Keeling National Park

Pemberitahuan niat untuk mengumpam semut kuning

Parks Australia ingin memberitahu masyarakat Cocos tentang niat kami untuk mengumpam semut kuning di Pulu Blan Madar dalam beberapa minggu akan datang. Baru-baru ini, kami telah memperhatikan banyak semut kuning yang boleh memberi kesan kepada kehidupan cicak buntut biru Pulu Krismas yang masih hidup. Mengumpam hanya akan memakan masa 1-2 hari tetapi akan diulang 3 kali setiap 3 bulan. Kami akan menggunakan gel Fipronil di dalam tempat kotak kecil yang membolehkan hanya semut yang masuk.

Walaupun ada usaha untuk memastikan Pulu Blan Madar bebas dari tikus, kami baru-baru ini mengalami banyak tikus, kami telah memasang 4 jipah Good Nature di Blan dan Blan Madar untuk berusaha mengurangkan tikus pada minimal.

Sekiranya pigi di Pulu Blan atau Blan Madar, ingatlah untuk memeriksa sekoci anda untuk mencari binatang yang tidak diinginkan seperti tikus, alipan dan wasp. Sangat penting untuk kehidupan cicak buntut biru di pulu-pulu tetap bebas dari sebarang gangguan.

PKNP Community Management Komiti

Kami mengucapkan terima kasih kepada memba yang keluar Bob Watson, Peter Wicks, Andrea Selvey dan Haji Badlu ketika mereka mundur dari Komiti Komuniti Managemen. Terima kasih Haji Badlu atas tanggung jawab anda terhadap mitingan dan wawasan sejarah yang berharga selama lebih dari 15 tahun.

Kami menyambut Cr Jamil Ibram masuk Komiti untuk tahun 2020.

Kami kini mempunyai dua jawatan kosong untuk Komiti sukarela yang didirikan pada tahun 1995 ketika Park pertama kali diisytiharkan. Sekiranya anda mempunyai kepentingan dalam pengurusan Pulu Keeling, sila nyatakan minat anda melalui talipun di nomor 9162 6678 atau pulukeelingnationalpark@awe.gov.au paling lambat pada hari Jumaat 19 Jun. Komiti memba kami sangat dihargai.

Kami baru-baru ini memasang tanda di tempat yang dikenali sebagai kubur Nek Katek di PKNP. Ini adalah salah satu projek yang dibantu oleh Komiti kami. Kami juga ingin mengucapkan terima kasih kepada Nek Amansha, Nek Su, Wak James, JCR, Konsel dan ABF yang sudah membantu kami mencari cerita ini dan menjadikan tempat ini sebagai tempat peringatan dan renungan.

Parks Australia | PO Box 1043 Cocos Keeling Islands Indian Ocean 6799

T: +61 8 9162 6678 | E: pulukeelingnationalpark@environment.gov.au | W: environment.gov.au/pulu-keeling



Photos needed!

Do you have any photos of Cocos Islands over the years?

The Shire of Cocos Keeling Islands and the Cocos Keeling Islands Visitor Centre is inviting people to share their photos. Photos will be scanned and returned to you and the scanned image will become part of the Cocos Island Museum collection. We would like to then use the digitised photos in various heritage projects, including our oral history project. The images may become part of the Cocos Island Museum collection. The Museum aims to preserve and showcase local stories of Cocos Islanders. To find out more, or if you'd like to share your photos, please contact Isa at the Shire or Seri or Lanif at the Visitor Centre today!

Gambar diperlukan!

Adakah anda mempunyai gambar lama Pulu Cocos selama ini?

Shire of Cocos Keeling Islands dan Cocos Keeling Islands Visitor Centre mengajak orang ramai untuk berkongsi gambar mereka. Gambar akan discan dan dikembalikan kepada anda dan gambar yang discan akan menjadi sebahagian daripada koleksi Museum Pulu Cocos. Kami ingin kemudian menggunakan gambar digital dalam beberapa projek warisan, termasuk projek sejarah oral kami. Gambar-gambar tersebut boleh menjadi sebahagian daripada koleksi Museum Pulu Cocos. Museum bertujuan untuk simpan dan tunjukkan kisah-kisah orang Pulu Cocos. Untuk mengetahui lebih lanjut, atau jika anda ingin berkongsi gambar anda, sila hubungi Pak Indra di Shire atau Mak Izahan atau Lanif di Visitor Centre hari ini!



What's On at IOGTA Cocos (Keeling) Islands?

IOGTA remains dedicated to servicing the communities of Christmas and Cocos (Keeling) Islands and as COVID-19 travel restrictions ease, IOGTA are very pleased to commence training delivery on Cocos once again.

Here's an update on what we have got on in June 2020. We encourage the Cocos community to continue to think of IOGTA for any labour hire needs, training requirements, apprenticeship & traineeship information and employment assistance. Please contact us so we can help you!

Recreational Skippers Ticket



Scheduled: between Wednesday 8th July - Thursday 16th July
RTO & Trainer: Yachting WA (RTO# 51536), Digby Edwards
Cost: \$200 per person (Under 18 years old)
 \$250 per person (Over 18 years old)
Prerequisites: Must be minimum 14 years old, able to meet pre-learning and ID requirements

1000 Jobs Package Wage Subsidy

Could your business use up to \$57,000 in wage subsidies and retention bonuses?
 Applications for the CDP 1000 Jobs Package are still open but places are limited and employers are encouraged to submit their proposals **as soon as possible** to avoid disappointment. Positions must be new, ongoing to the organisation and additional payments are available directly to the successful employee if they remain in employment.
Call IOGTA to find out if your business is eligible*
 *Exclusions apply



Provide First Aid & CPR



IOGTA have developed new materials for courses:

- HLTAID003 Provide First Aid; and
- HLTAID001 Provide Cardiopulmonary Resuscitation

which can be completed by a Learner electronically prior to attending training. This reduces the amount of time spent face-to-face and minimises the risks associated with being in close personal contact with others. The materials are being implemented on Christmas Island first and will then be rolled out on Cocos once all requirements are in place.

COVID-19 Cleaning Workshops

Does your workplace need to complete a COVID-19 Return to Work Plan? IOGTA are available to assist with your translation and/or interpretation needs. You are also welcome to use one of our laptops at our comfortable office to complete the form.
 Please call our offices to make an appointment as pre-booking is required due to physical distancing measures.



Christmas Island Office

(08) 9164 7220 | info@iogta.wa.edu.au

Cocos (Keeling) Islands

(08) 9162 6776 | aindli@iogta.wa.edu.au / asma@iogta.wa.edu.au

"LAWA's IOTs Service is fully funded by the Australian Government"**Distributing intimate images of people without consent I**

These are short articles about legal issues that may interest you. They are not legal advice. You should always get individual legal advice for your situation.

The social phenomenon of people distributing intimate images (for eg a nude photograph or video of sexual activity) of other people without their consent has become more common recently. It has been facilitated by the increasing use of social media and technology.

One common example is where one person sends their partner, whilst they are in a relationship, a nude photograph of themselves. Later, the relationship ends and the receiver of the photograph distributes that photograph to others, without their ex-partner's consent. It is often to humiliate their ex-partner and take revenge upon them.

Distributing an intimate image without consent became a criminal offence in WA and in the Indian Ocean Territories on 15 April 2019.

We will talk about the offence, definitions, penalties and rectification orders in the first article and defences to the charge and making a threat to distribute an intimate image and other things in the second article.

The offence and penalties

You commit a crime if you distribute an intimate image of another person who does not consent to the distribution. The offence can be dealt with by either the Magistrates or District Court (commonly called an "either way" offence).

[It must be dealt with by the Magistrates Court unless you or the Prosecutor ask for it to be dealt with by the District Court and the Magistrate agrees. The Magistrate must apply rules to determine whether it should be dealt with by the District Court.](#)

The maximum penalty is 3 years imprisonment if you are dealt with by the District Court ("on indictment"). The maximum penalty is 18 months imprisonment and a fine of \$18,000 if you are dealt with by the Magistrates Court.

What is an "intimate image"?

An intimate image is either a still or moving image (eg photo or video, including photoshopped or edited images) that shows, where a person would normally expect to have privacy:

- A person's genital or anal area, either bare, or covered by underwear or
- For a female, or person identifying as female, her breasts, either bare or covered by underwear or
- The person engaged in a private act (see below).

Note that it would not include situations where a person does not expect to have privacy, such as a model modelling underwear in a lingerie fashion parade.

What is a "private act"?

A private act is where a person is:

- in a state of undress
- having a shower, or bathing, or using the toilet or
- engaged in a sexual act.

What is consent?

Consent is real agreement. Consent must be freely and voluntarily given. It is not freely and voluntarily given if it is obtained by force, threat, intimidation, or deceit. For example, consenting because the distributor threatened that he would show nude photographs of you to your parents unless you let him send them to his mates would not be consent.

Consent on one occasion does not mean consent for other occasions. Consent given to one person does not provide consent to other persons. Consent to one particular form of distribution does not provide consent to other forms of distribution.

Also, distribution by the person in the image does not provide consent for further distribution by other people.

Court can order person charged to rectify (remove) the distribution of the intimate image

If a person is charged with the offence, a Court can order that person to take reasonable steps to get rid of (remove, delete, destroy) the intimate image within a certain time frame. This is called a rectification order. It does not matter if a person is convicted of the offence or not.

For example, if an accused person has sent a photograph of an ex-girlfriend who is naked to his friend, without her consent, a Court might make a rectification order at his first Court appearance. The order might be that he deletes the photograph within 48 hours. This order can be made even if he eventually pleads not guilty and is found not guilty of the offence.

If the person fails to comply with a rectification order, it is a simple offence (which means it can only be dealt with by the Magistrates Court). The maximum penalty is imprisonment for 12 months and a fine of \$12,000.

What if you send an intimate image of yourself?

If you are an adult, this is not a criminal offence. It is only a criminal offence if you distribute an intimate image of someone else, without their consent.

If you are under 18 years, it can be an offence to distribute an intimate image of yourself. You can be charged with an offence under child pornography laws.

"Serbis LAWA's IOTs dibiayai sepenuhnya oleh Kerajaan Australia"**Mengedarkan gambar intim orang tanpa izin I**

Ini adalah berita pendek mengenai masalah undang-undang yang mungkin menarik bagi [anda](#). Ini bukan nasihat undang-undang. Anda harus selalu mendapatkan nasihat undang-undang masing-masing untuk keadaan anda.

Fenomena sosial orang yang menyebarkan gambar intim (contohnya gambar telanjang atau video aktiviti seksual) orang lain tanpa persetujuan mereka menjadi lebih biasa baru-baru ini. Ini telah difasilitasi oleh peningkatan penggunaan media sosial dan teknologi.

Salah satu contoh umum adalah di mana seseorang menghantar pasangan mereka, semasa mereka menjalinkan hubungan, gambar diri mereka yang telanjang. Kemudian, hubungan berakhir dan penerima gambar menyebarkan gambar itu kepada orang lain, tanpa persetujuan bekas pasangan mereka. Selalunya menghina bekas pasangan mereka dan membalas dendam terhadap mereka.

Menyebarkan gambar intim tanpa persetujuan menjadi kesalahan jenayah di WA dan di Wilayah Lautan Hindi pada 15 April 2019.

Kami akan membicarakan kesalahan, maksud, hukuman dan perintah pembetulan dalam artikel pertama dan pertahanan terhadap pertuduhan dan membuat ancaman untuk menyebarkan gambar intim dan perkara lain dalam artikel kedua.

Kesalahan dan hukuman Anda melakukan kejahatan jika anda menyebarkan gambar intim orang lain yang tidak bersetuju dengan pendedaran itu. Kesalahan tersebut dapat ditangani oleh Majistret atau District Court (biasanya disebut sebagai kesalahan "apa pun").

[Perkara itu mesti ditangani oleh Mahkamah Majistret melainkan anda atau Penuntut meminta agar perkara itu ditangani oleh District Court dan Majistret bersetuju. Majistret mesti menggunakan peraturan untuk menentukan sama ada ia harus ditangani oleh District Court.](#)

Hukuman maksimum adalah penjara 3 tahun jika anda diadili oleh District Court ("atas dakwaan"). Hukuman maksimum adalah penjara 18 bulan dan denda \$18,000 jika anda ditangani oleh Mahkamah Majistret.

Apa itu "gambar intim"? Gambar intim adalah gambar diam atau bergerak (contohnya foto atau video, termasuk gambar yang dipotong atau diedit) yang menunjukkan, di mana seseorang biasanya mengharapkan privasi:

- Kawasan kemaluan atau dubur seseorang, sama ada telanjang, atau ditutup dengan seluar dalam atau
- Untuk perempuan, atau orang yang dikenali sebagai perempuan, payudaranya, telanjang atau ditutupi dengan coli atau
- Orang yang melakukan perbuatan pribadi (lihat di bawah).

Perhatikan bahawa itu tidak termasuk situasi di mana seseorang tidak mengharapkan kerahsiaan, seperti model memodelkan pakaian dalam didalam fesyen pakaian dalam.

Apa itu "tindakan pribadi"?

Perbuatan pribadi adalah dimana seseorang:

- dalam keadaan membukak pakaian
- mandi, atau menggunakan tandas atau
- terlibat dalam perbuatan seksual.

Apa itu persetujuan? Persetujuan adalah perjanjian sebenar. Persetujuan mesti diberikan secara bebas dan sukarela. Ia tidak diberikan secara bebas dan sukarela jika ia diperoleh secara paksa, ancaman, intimidasi, atau penipuan. Contohnya, memberi persetujuan kerana pendedar mengancam bahawa dia akan menunjukkan gambar telanjang anda kepada ibu bapa anda melainkan anda membiarkannya menghantarnya kepada kawan nya tidak akan mendapat persetujuan.

Persetujuan pada satu kesempatan tidak bermaksud persetujuan untuk yang lain. Persetujuan yang diberikan kepada satu orang tidak memberikan persetujuan kepada orang lain. Persetujuan untuk satu cara pendedaran tertentu tidak memberikan persetujuan kepada cara pendedaran lain.

Juga, pendedaran oleh orang dalam gambar tidak memberikan persetujuan untuk pendedaran lebih lanjut oleh orang lain.

Mahkamah boleh memerintahkan orang yang ditugaskan untuk membetulkan (membuang) penyebaran gambar intim

Sekiranya seseorang didakwa atas kesalahan itu, Mahkamah dapat memerintahkan orang itu untuk mengambil langkah untuk menyingkirkan (menghapus, memusnahkan) gambar intim dalam jangka masa tertentu. Ini dipanggil perintah pembetulan. Tidak kira sama ada seseorang itu dihukum atas kesalahan itu atau tidak.

Sebagai contoh, jika seseorang yang dituduh telah menghantar gambar bekas kekasihnya yang telanjang kepada kawannya, tanpa persetujuannya, Mahkamah mungkin akan membuat perintah pembetulan pada kali pertama kali muncul di Mahkamah. Perintahnya mungkin dia akan menghapus gambar tersebut dalam 48 jam. Perintah ini boleh dibuat walaupun dia akhirnya mengaku tidak bersalah dan didapati tidak melakukan kesalahan itu.

Sekiranya orang tersebut tidak mematuhi perintah pembetulan, itu adalah kesalahan yang mudah (yang bermaksud ia hanya boleh ditangani oleh Mahkamah Majistret). Hukuman maksimum adalah penjara selama 12 bulan dan denda \$12,000.

Bagaimana jika anda menghantar gambar intim anda? Sekiranya anda seorang dewasa, ini bukan kesalahan jenayah. Ini hanya kesalahan jenayah jika anda menyebarkan gambar intim orang lain, tanpa persetujuan mereka.

Sekiranya anda berusia di bawah 18 tahun, boleh menjadi kesalahan untuk menyebarkan gambar intim diri anda. Anda boleh didakwa atas kesalahan di bawah undang-undang pornografi kanak-kanak.



Wordsearch

U	T	B	R	N	M	S	H
M	A	E	R	C	E	C	I
O	O	B	E	A	C	H	M
M	B	B	M	E	W	S	W
G	N	I	M	M	I	W	S
H	E	U	U	P	O	O	L
P	O	H	S	R	I	O	U
A	U	T	H	E	M	H	M

SUMMER
SUN
ICE CREAM
BEACH
SEA
POOL
SWIMMING
HOT
BOAT

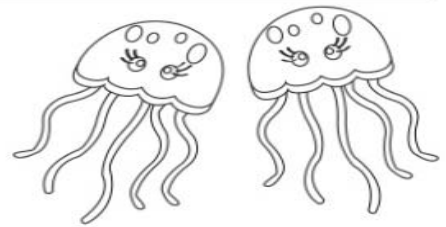

OPPOSITES

List the opposites.

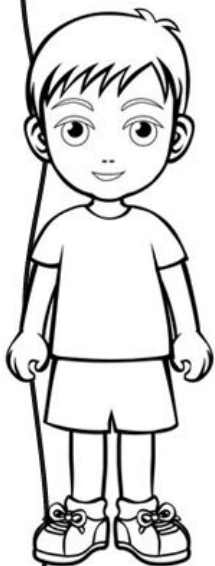

- boy _____
- black _____
- young _____
- big _____
- early _____
- loud _____
- down _____
- large _____
- fast _____
- low _____
- dark _____
- hard _____
- out _____
- dry _____
- good _____



Brain Teasers



1. You planted sunflower seeds in your back garden. Every day, the number of flowers doubles. If it takes 52 days for the flowers to fill the garden, how many days would it take for them to fill half the garden?
2. Your sock drawer only contains 18 white socks and 18 blue socks. How many times do you need to reach inside the drawer and take out a sock to guarantee a matching pair?
3. A boy was at a carnival and went to a booth where a man said to the boy, "If I write your exact weight on this piece of paper then you have to give me \$50, but if I cannot, I will pay you \$50." The boy looked around and saw no scale so he agrees, thinking no matter what the carry writes he'll just say he weighs more or less. In the end the boy ended up paying the man \$50. How did the man win the bet?

Answers on next page

CRISS-CROSS

Fill in the blanks with the words. To help you get started one letter is already in place.

5 letter words

- AMBER
- CLERK
- CLIFF
- EAGLE
- EGYPT
- EMPTY
- NYLON
- PSALM
- RHYME
- RULER
- STRAW
- STYLE

6 letter words

- AMULET
- COLLIE
- FOLDED
- GYPSUM
- LEAGUE
- LIGHTS
- REPEAT
- RHYTHM

7 letter words

- ARRANGE
- BAY LEAF
- BEAR CUB
- CAPTCHA
- CYCLONE
- HIT LIST
- INSTANT
- ISLANDS
- JAKARTA
- KINGDOM

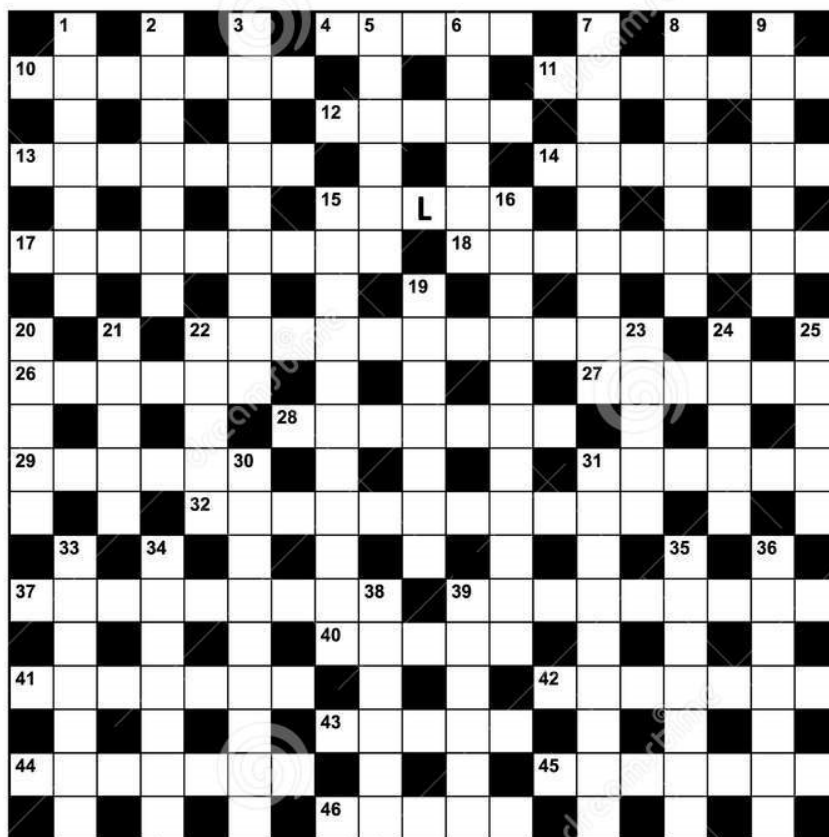

9 letter words

- LIBRARY
- ODYSSEY
- PEN NAME
- PYRAMID
- SATSUMA
- TRIREME
- USELESS
- VEHICLE

- ALABASTER
- COWBOY HAT
- DECORATED
- ESKIMO DOG

- FLAMINGOS
- GUARANTEE
- HYBRID CAR
- TRADITION

11 letter words

- RECTANGULAR
- RESPONSIBLE
- SOUTHAMPTON
- WROUGHT IRON

			1				9	2
9	8	7	3					1
1		5		8				7
	9	2		5		6	8	
	4						1	
	1	3		6		7	4	
2				1		3		4
3					6	1	7	8
8	7				4			

Su-
Corner

Brain Teasers Answers

1. It would take 51 days. If the number of flowers doubles every day, half the garden would be full the day before, on the 51st day.
 2. Three times. On the third time, you'll get either a white or a blue sock to match with one of the other two you've already grabbed.
 3. The man did exactly as he said he would and wrote "your exact weight" on the paper.

Next Generation (Down Wind from Yacht Club to the Long Beach).



Photo by: Helen Liu

Birthdays & Anniversaries



Wish to send loved ones special messages on their birthdays and anniversaries?

Drop an email to Azia Bulka at comms@cocos.wa.gov.au

The next edition of The Atoll will be produced on:

*Edisi The Atoll selanjutnya akan
dikeluarkan pada:*

Friday 26th June 2020

All items/materials must be received by:

Semua majalah mesti diterima sebelum:

3pm, Tuesday 23rd June 2020

Have Your Say



Letters to the Editor will either be accepted or rejected by the Editor. Items need to be:

- Accurate and/or factual
- Not defamatory or inflammatory

Please take into consideration our format when preparing your items/materials to make the most of the spaces available.

The Atoll publication staffs reserves the right to edit the formatting of articles submitted for publication.

To ensure a timely distribution of the newsletter, we request that all items/materials be forwarded before 3pm, 2 days prior to its distribution date. Please contact the Cocos CRC for deadlines and advertising rates.

Disclaimer: The views expressed in articles in this newsletter are not necessarily the views of the editors or other volunteers who work to produce The Atoll. The editor has the right to withhold, edit or abbreviate items as considered necessary. No responsibility is accepted for any statement of opinion, any error or omissions.

Advertisement Rates

Please contact the Cocos Keeling Islands Community Resource Centre for a full rate schedule.

Translation fees apply

Materials should preferably be emailed to:
cocosislands@crc.net.au

2020 COCOS ISLANDS COMMUNITY EVENTS

If you would like to include your community event, please contact the
CRC with your details.

POSTPONED

WI Market Day
Cocos Islands CRC

23 SEPTEMBER

Shire Council Meeting
Council Chambers, HI

13 DECEMBER

Kids Christmas Party
Cocos Club

POSTPONED

Administrators Ball
Cocos Islands

26 SEPTEMBER

AFL Grand Final
Cocos Club, WI

31 DECEMBER

New Years Eve
Cocos Club

24 JUNE

Shire Council Meeting
CRC Conference Room

3 NOVEMBER

Melbourne Cup
Cocos Club

22 JULY

Shire Council Meeting
Council Chambers, HI

4 NOVEMBER

Shire Council Meeting
CRC Conference Room, WI

26 AUGUST

Shire Council Meeting
CRC Conference Room, WI

9 DECEMBER

Shire Council Meeting
Council Chambers, HI

19 SEPTEMBER

WI Market Day
Cocos Islands CRC

12 DECEMBER

WI Market Day
Cocos Islands CRC

This is a **FREE** service for our Community.

P | 9162 7707 E | cocosislands@crc.net.au W | www.cocos.crc.net.au



Australian Government
Department of Infrastructure, Transport,
Regional Development and Communications



Department of
Primary Industries and
Regional Development

Proudly supported by: